

본 도면은 리스광시스템(주)의 자산이므로 허가없이 복제 및 외부 반출을 금함.  
 This drawing and ideas are protected by LEES Optical System, Inc.

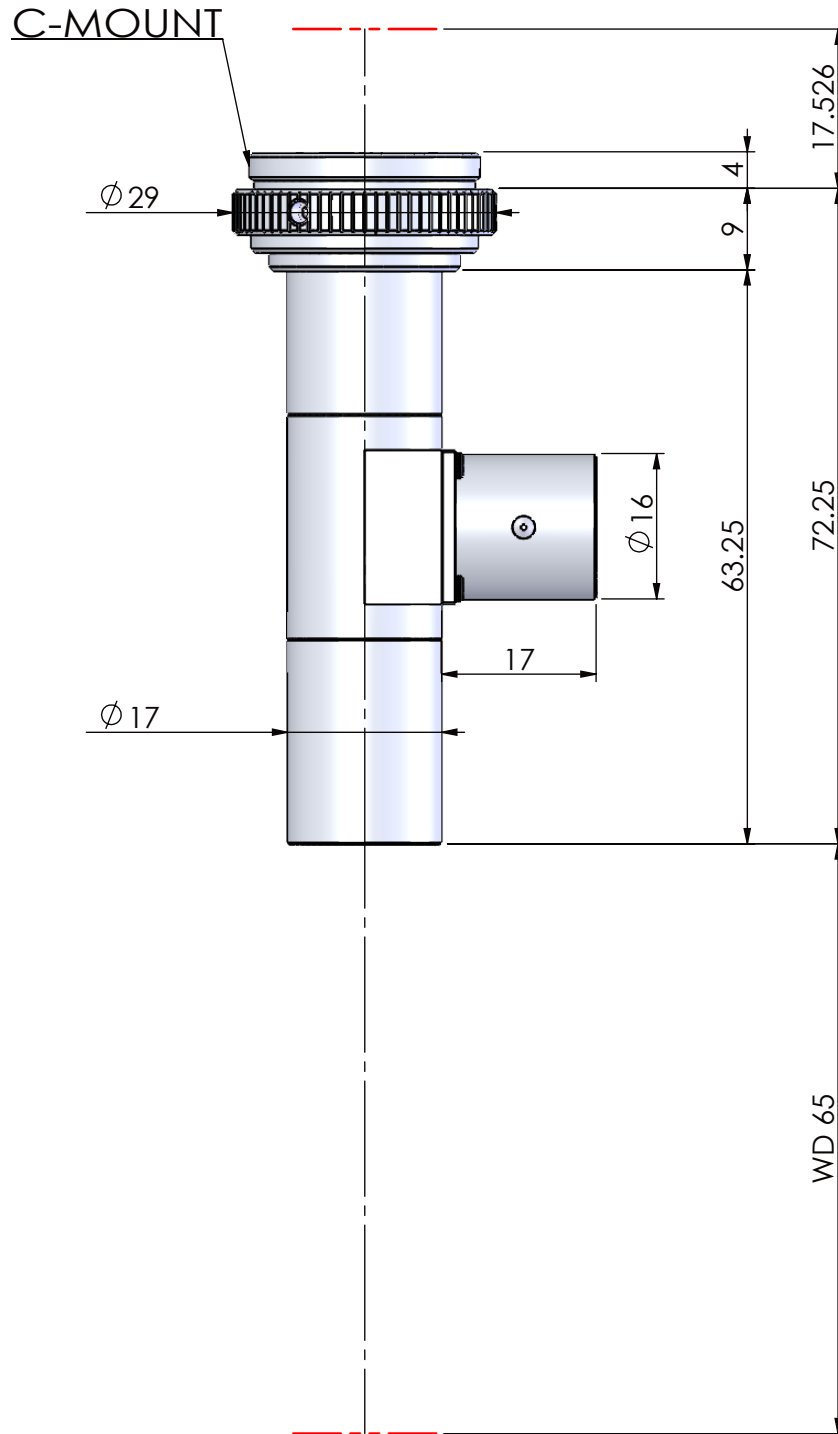

OPTICAL MAGNIFICATION	WD(mm)	DEPTH OF FIELD	RESOLUTION	NA	PARAXIAL WORKING F/#	F.O.V.	MOUNT
2.0X	65	$\pm 0.142\text{mm}$	4.8 $\mu\text{m}$	0.07	14.2	H3.2 X V2.4(1/2") H2.4 X V1.8(1/3")	C-MOUNT

CORPORATE NAME	MODEL (ON/COAXIAL)	SCALE
	TITLE	1.2:1
	TLW 65SERIES	DIMENSIONS
	TLW65D - 2.0X	mm