

본 도면은 리스광시스템(주)의 자산이므로 허가없이 복제 및 외부 반출을 금함.
 This drawing and ideas are protected by LEES Optical System, Inc.

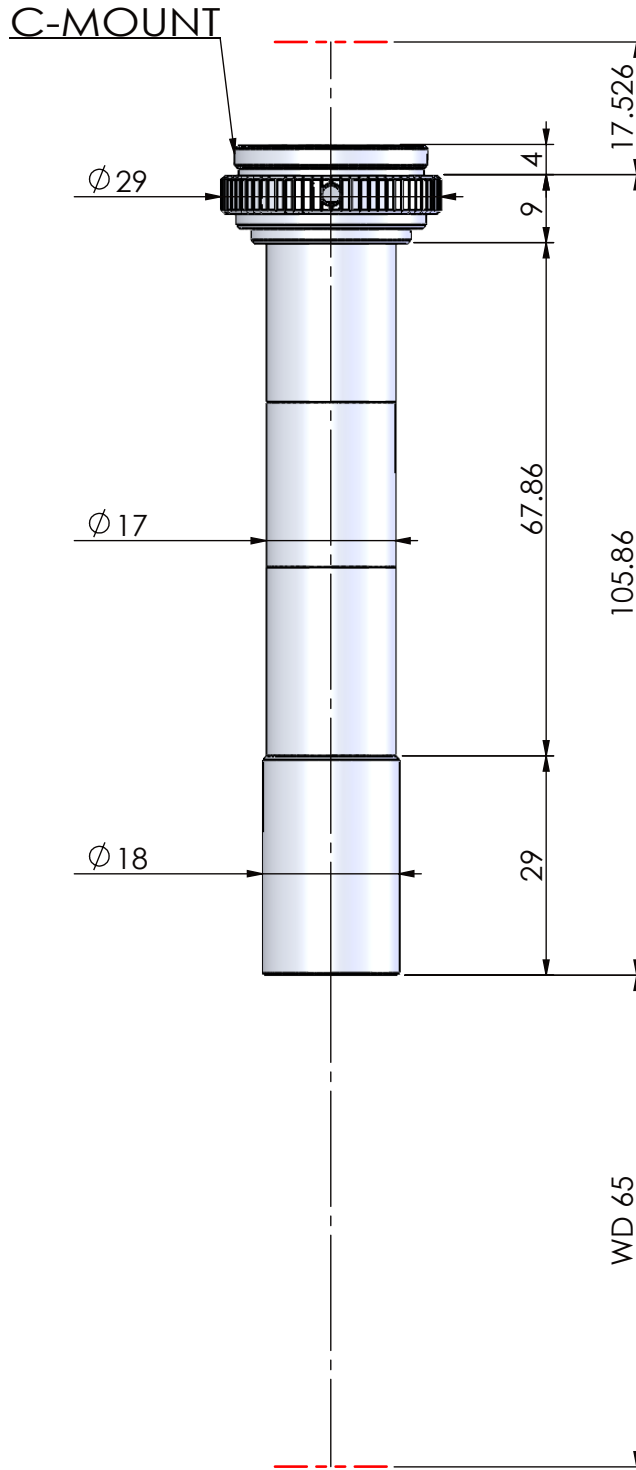

OPTICAL MAGNIFICATION	WD(mm)	DEPTH OF FIELD	RESOLUTION	NA	PARAXIAL WORKING F/#	F.O.V.	MOUNT
4.0X	65	±0.062 mm	4.2um	0.08	24.9	H2.2 X V1.6(2/3") H1.6 X V1.2(1/2")	C-MOUNT

CORPORATE NAME	MODEL (ON/COAXIAL)	SCALE
	TITLE	1:1
	TLW 65SERIES	DIMENSIONS
	TLW65 - 4.0X	mm