

본 도면은 리스광시스템(주)의 자산이므로 허가없이 복제 및 외부 반출을 금함.
 This drawing and ideas are protected by LEES Optical System, Inc.

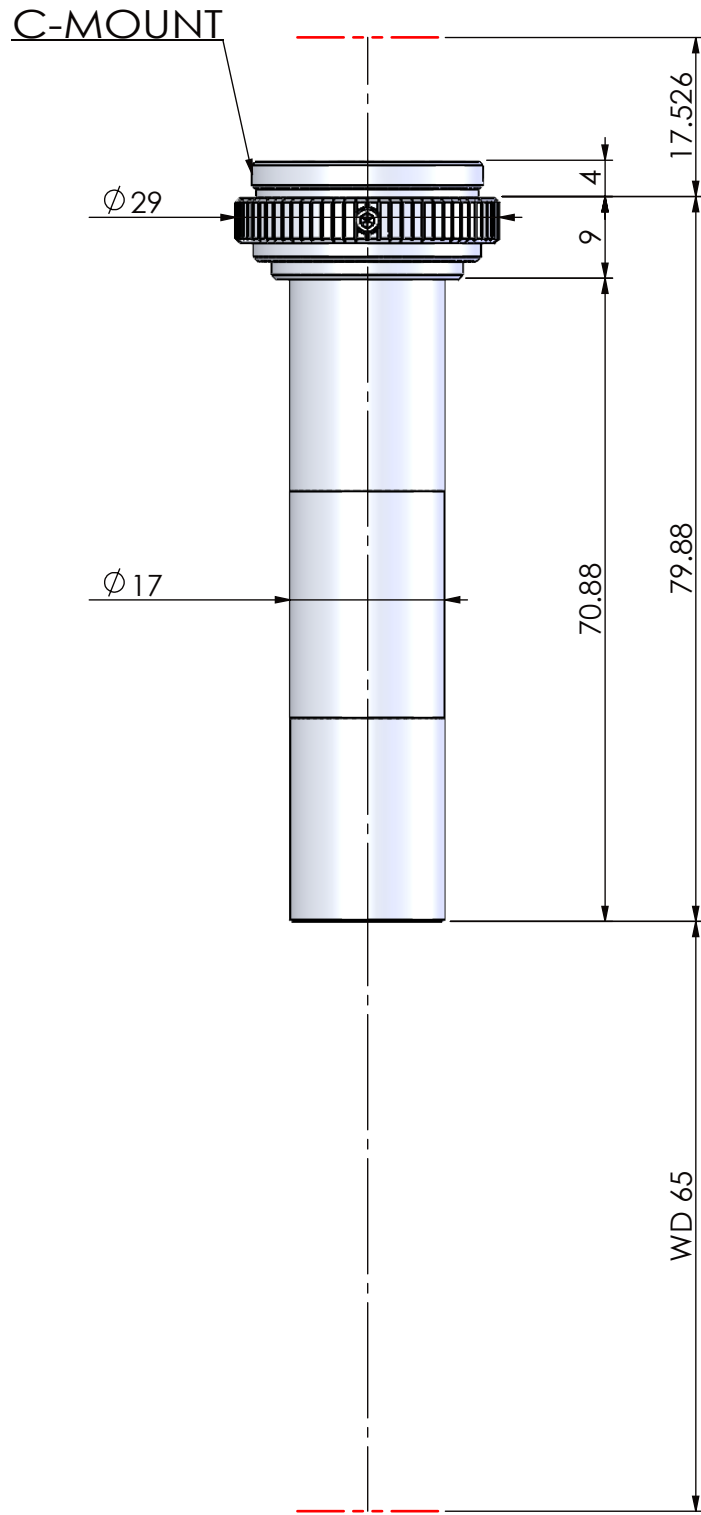

OPTICAL MAGNIFICATION	WD(mm)	DEPTH OF FIELD	RESOLUTION	NA	PARAXIAL WORKING F/#	F.O.V.	MOUNT
2.5X	65	$\pm 0.114\text{mm}$	4.8 μm	0.07	17.6	H2.56 X V1.92(1/2") H1.92 X V1.44(1/3")	C-MOUNT

CORPORATE NAME	MODEL (ON/COAXIAL)	SCALE
 SINCE 1999	TITLE	1.2:1
	TLW 65SERIES	DIMENSIONS
	TLW65 - 2.5X	mm