

본 도면은 리스광시스템(주)의 자산이므로 허가없이 복제 및 외부 반출을 금함.
 This drawing and ideas are protected by LEES Optical System, Inc.

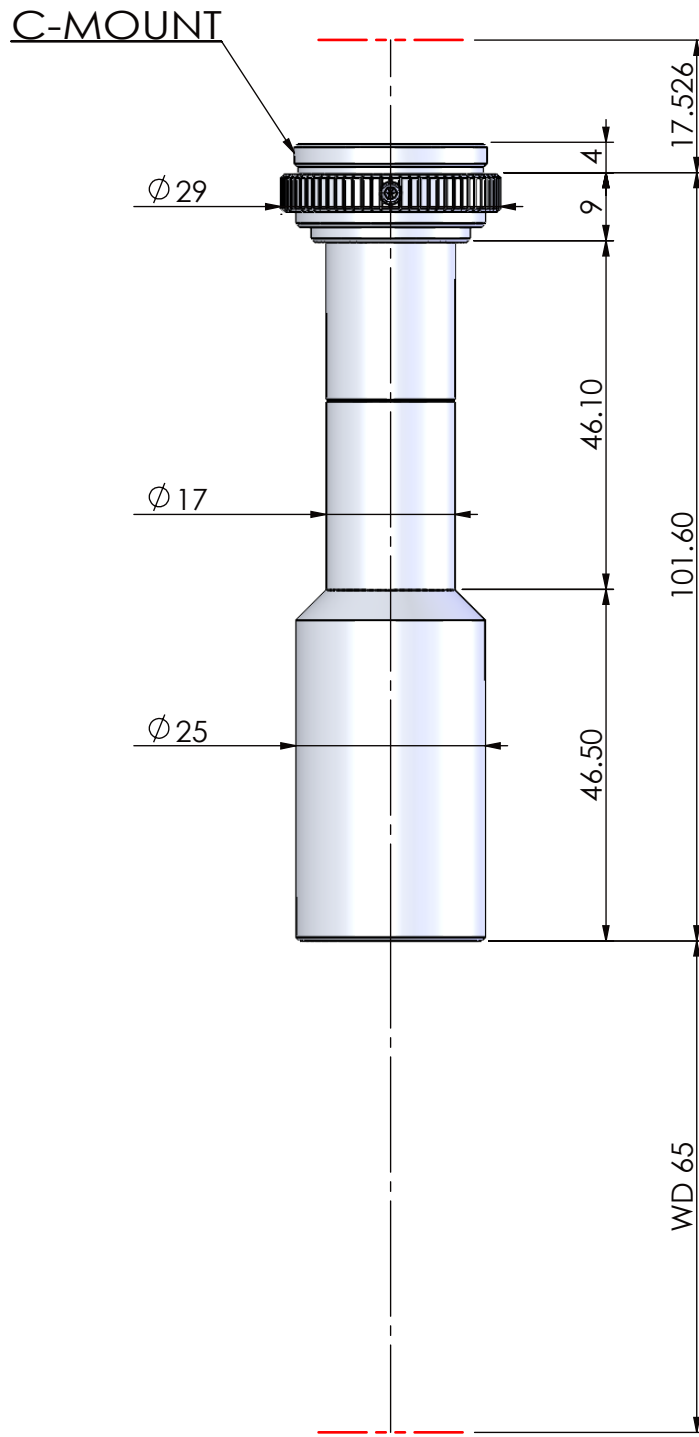

OPTICAL MAGNIFICATION	WD(mm)	DEPTH OF FIELD	RESOLUTION	NA	PARAXIAL WORKING F/#	F.O.V.	MOUNT
0.8X	65	±0.834mm	11.2um	0.03	13.3	H 11.0 X V8.25(2/3") H8.0 X V6.0(1/2")	C-MOUNT

CORPORATE NAME	MODEL (ON/COAXIAL)	SCALE
 SINCE 1999	TITLE	1:1
	TLW 65SERIES	DIMENSIONS
	TLW65-0.8X	mm