

본 도면은 리스광시스템(주)의 자산이므로 허가없이 복제 및 외부 반출을 금함.
 This drawing and ideas are protected by LEES Optical System, Inc.

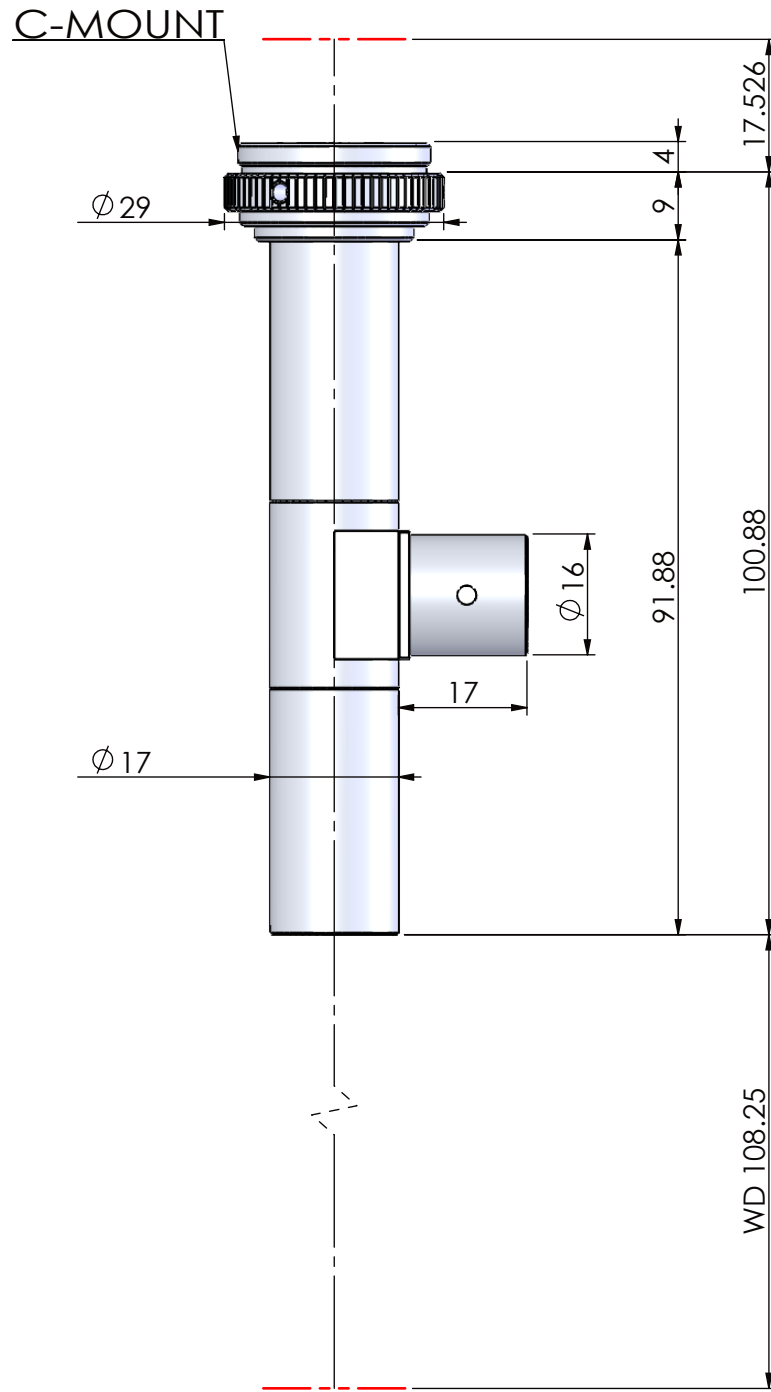

OPTICAL MAGNIFICATION	WD(mm)	DEPTH OF FIELD	RESOLUTION	NA	PARAXIAL WORKING F/#	F.O.V.	MOUNT
2.5X	110	±0.174 mm	7.4um	0.046	27.1	H2.56 X V1.92(1/2") H1.92 X V1.44(1/3")	C-MOUNT

CORPORATE NAME	MODEL (ON/COAXIAL)	SCALE
	TITLE	1:1
	TLW 110SERIES	DIMENSIONS
	TLW110D-2.5X	mm