

본 도면은 리스광시스템(주)의 자산이므로 허가없이 복제 및 외부 반출을 금함.
 This drawing and ideas are protected by LEES Optical System, Inc.

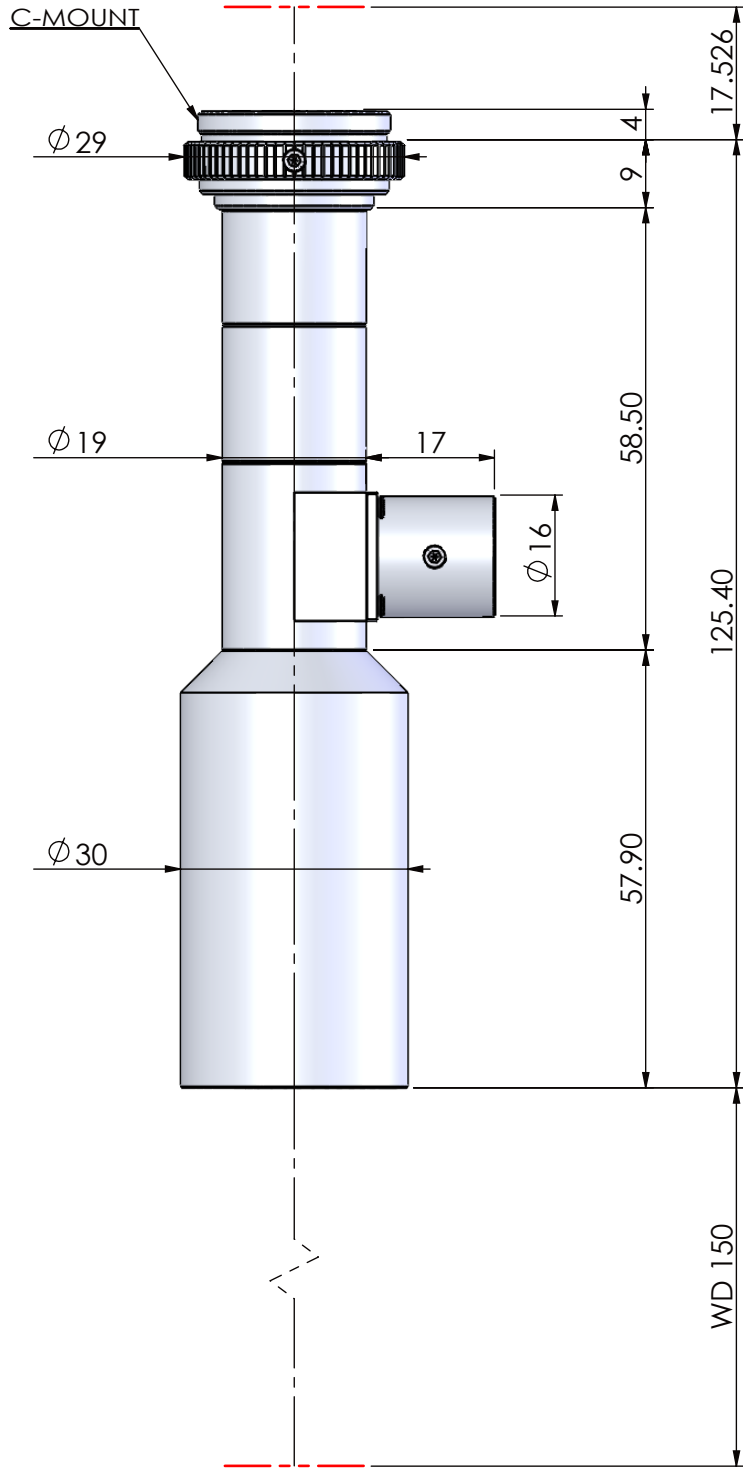

OPTICAL MAGNIFICATION	WD(mm)	DEPTH OF FIELD	RESOLUTION	NA	PARAXIAL WORKING F/#	F.O.V.	MOUNT
1.0X	150	± 0.499 mm	8.4 μ m	0.04	12.5	H8.8 X V6.6(2/3") H6.4 X V4.8(1/2")	C-MOUNT

CORPORATE NAME	MODEL (ON/COAXIAL)	SCALE
	TITLE	1:1
	TLW150 SERIES	DIMENSIONS
	TLW150D-1.0X	mm