

본 도면은 리스광시스템(주)의 자산이므로 허가없이 복제 및 외부 반출을 금함.
 This drawing and ideas are protected by LEES Optical System, Inc.

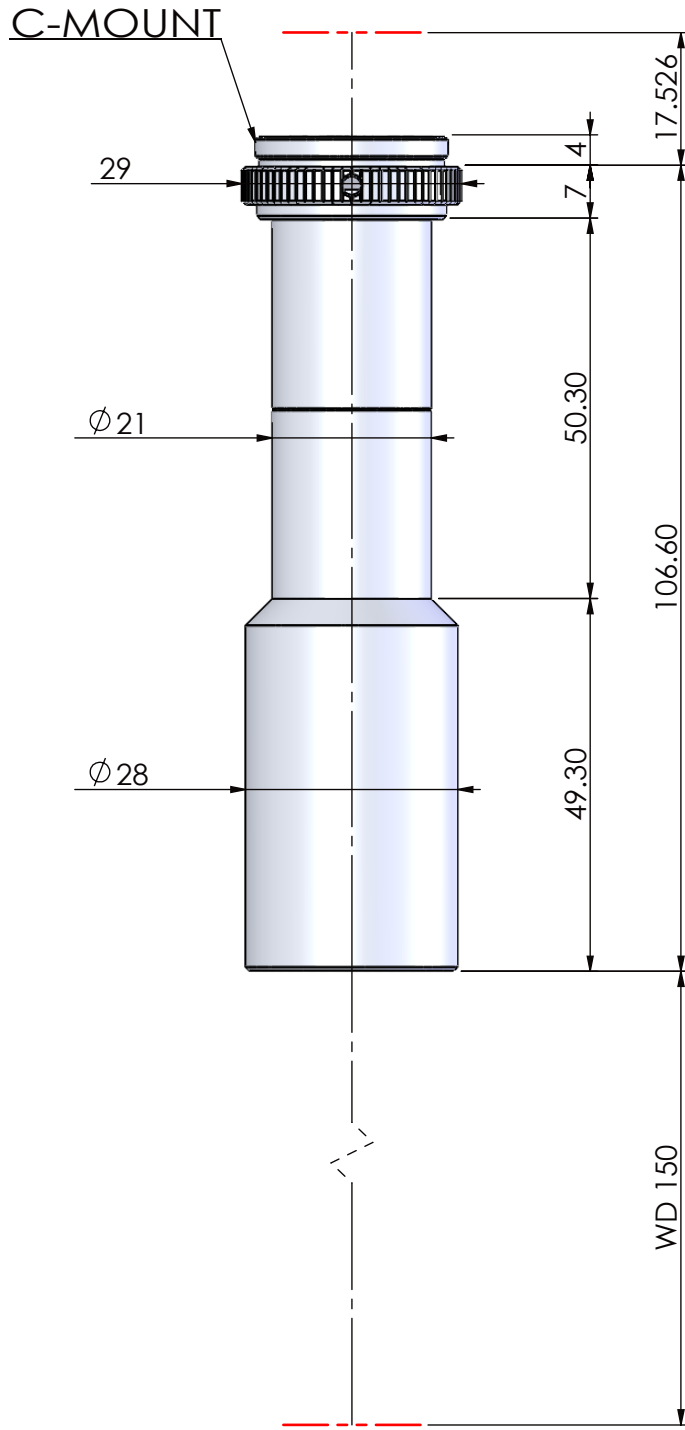

OPTICAL MAGNIFICATION	WD(mm)	DEPTH OF FIELD	RESOLUTION	NA	PARAXIAL WORKING F/#	F.O.V.	MOUNT
0.6X	150	±1.344 mm	13.97um	0.024	12.1	H10.67 X V8.0(1/2") H8.0 X V6.0(1/3")	C-MOUNT

CORPORATE NAME	MODEL (ON/COAXIAL)	SCALE
	TITLE	1:1
	TLW150 SERIES	DIMENSIONS
	TLW150-0.6X	mm