

본 도면은 리스광시스템(주)의 자산이므로 허가없이 복제 및 외부 반출을 금함.  
 This drawing and ideas are protected by LEES Optical System, Inc.

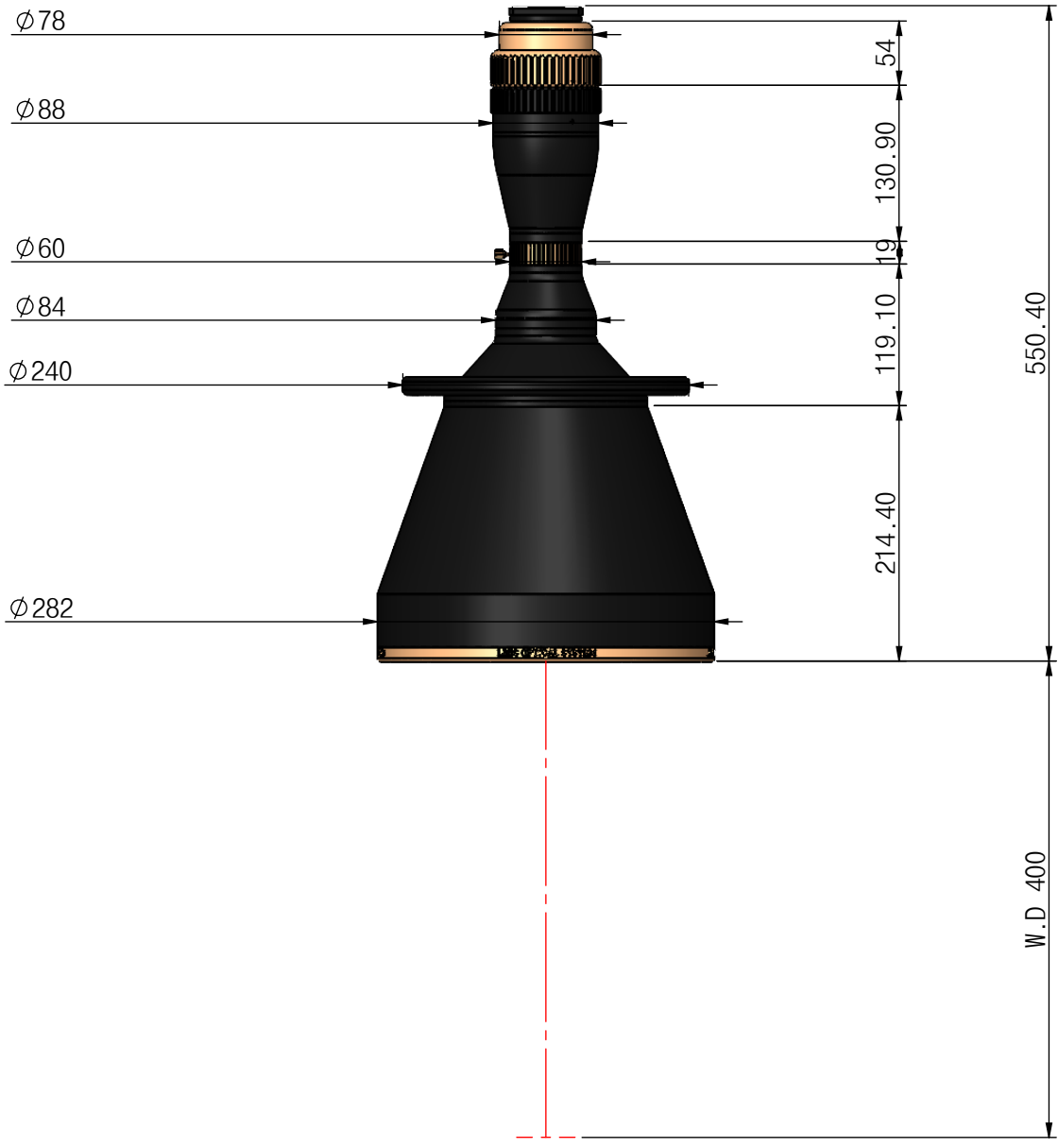

OPTICAL MAGNIFICATION	WD(mm)	DEPTH OF FIELD	RESOLUTION	NA	PARAXIAL WORKING F/#	F.O.V.	MOUNT
0.21X	400mm	±4.029mm	25.81um	0.013	8	172.228X114.819X206.990	

CORPORATE NAME		MODEL (ON/COAXIAL)		SCALE
		TITLE		1:6
		LP16001		DIMENSIONS
		TLW400-0.21X-29M		mm