

본 도면은 리스광시스템(주)의 자산이므로 허가없이 복제 및 외부 반출을 금함.
 This drawing and ideas are protected by LEES Optical System, Inc.

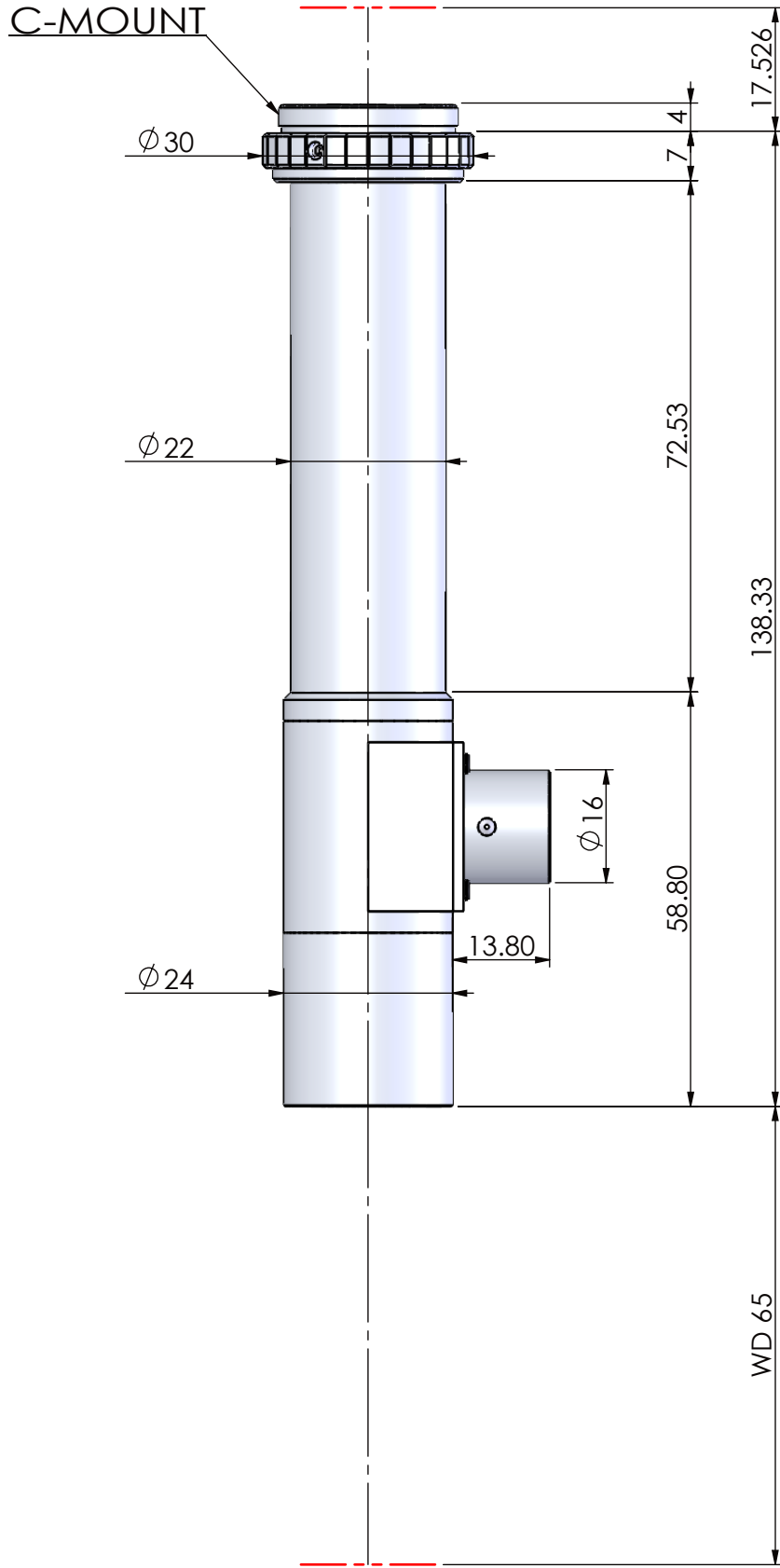

OPTICAL MAGNIFICATION	WD(mm)	DEPTH OF FIELD	RESOLUTION	NA	PARAXIAL WORKING F/#	F.O.V.	MOUNT
6.0X	65	±0.029 mm	3um	0.112	26.7	H1.46 X V1.12(2/3") H1.06 X V0.8(1/2")	C-MOUNT

CORPORATE NAME	MODEL (ON/COAXIAL)	SCALE
 SINCE 1999	TITLE	1:1
	TLW65 SERIES	DIMENSIONS
	TLW65D-6.0X-HR	mm