

본 도면은 리스광시스템(주)의 자산이므로 허가없이 복제 및 외부 반출을 금함.
 This drawing and ideas are protected by LEES Optical System, Inc.

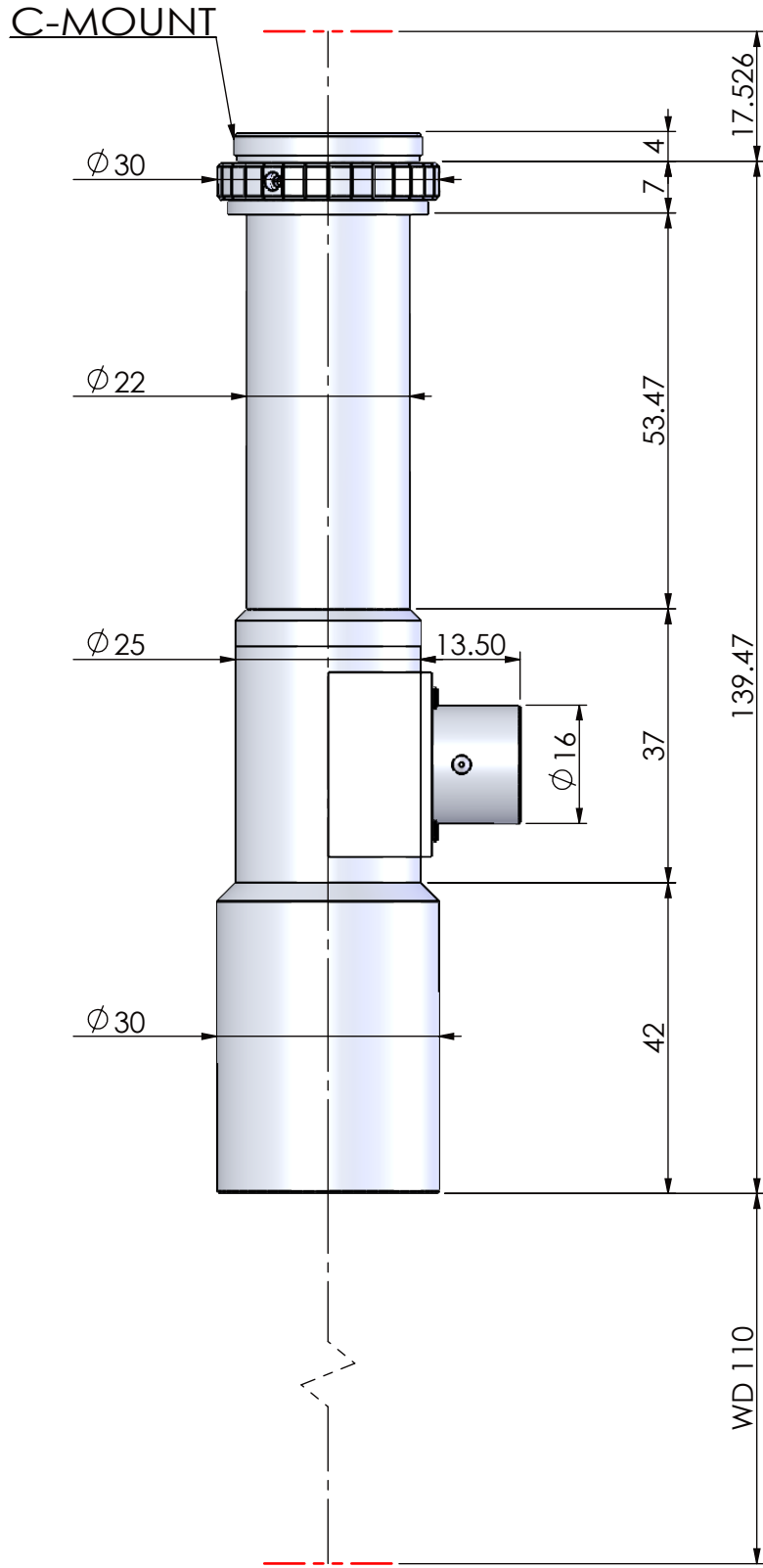

OPTICAL MAGNIFICATION	WD(mm)	DEPTH OF FIELD	RESOLUTION	NA	PARAXIAL WORKING F/#	F.O.V.	MOUNT
4.0X	110	±0.055 mm	3.8um	0.09	22	H2.2 X V1.65(2/3") H1.6 X V1.2(1/2")	C-MOUNT

CORPORATE NAME		MODEL (ON/COAXIAL)		SCALE
 SINCE 1999		TITLE		1:1
		TLW 110SERIES		DIMENSIONS
		TLW110D-4.0X-HR		mm