

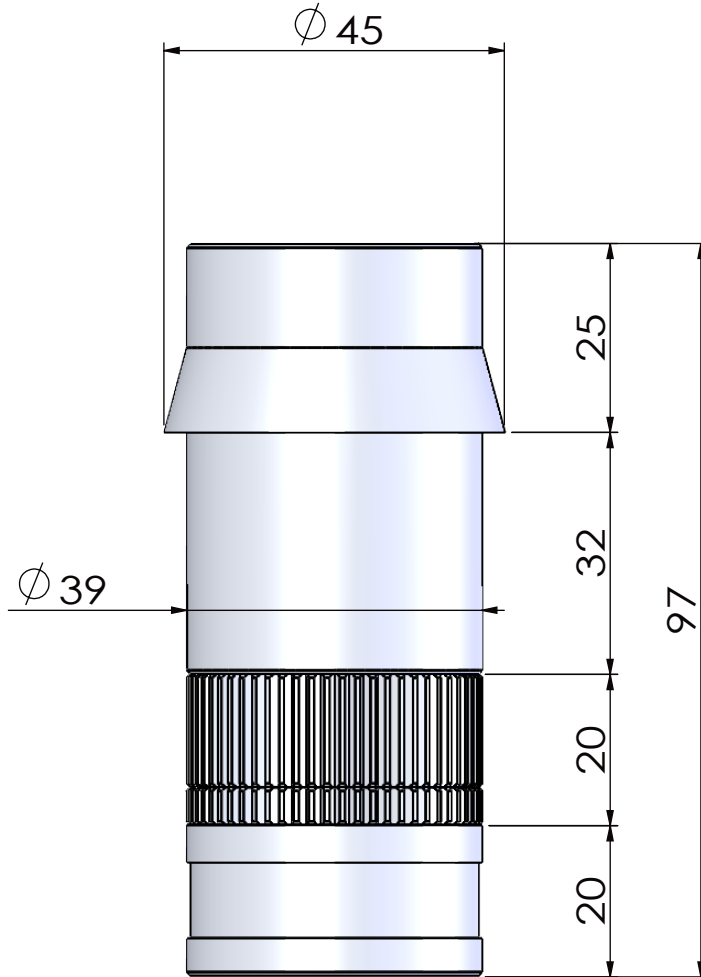

본 도면은 리스광시스템(주)의 자산이므로 허가없이 복제 및 외부 반출을 금함.
 This drawing and ideas are protected by LEES Optical System, Inc.



TUBE MAGNIFICATION	EFFECTIVE FOCAL LENGTH	NA	F/Number	Optical Maximum Distortion	Sensor Size
0.33X	66mm	0.075	6.6	<0.1%	6mm

CORPORATE NAME	MODEL (ON/COAXIAL)	Scale
	TITLE	1:1
	PARFOCAL TUBE LENS	Dimensions
	ST-N66-033	mm